



**Bedienungsanleitung**  
**Instruction manual**  
**Notice d'utilisation**  
**Gebruiksaanwijzing**  
**Istruzioni per l'uso**  
**Bruksanvisning**  
**Instrucciones de uso**

**5IE64252**  
**5IE84252**  
**5II84251**  
**5II94291**  
**5IB64211**  
**5IZ34291**

Register your  
new device on  
YourBlaupunkt:  
**blaupunkt-  
einbaugeraete.com**



***Enjoy it.***

**Kochfeld autark, Induktion**  
**Stand-alone hob, induction**  
**Table de cuisson autonome à induction**  
**Kookveld zelfstandig, inductie**  
**Piano cottura autonomo, induzione**  
**Fristående matlagningsyta, induktion**  
**Placa de vitrocerámica independiente, inducción**

# TABLE OF CONTENTS

## **3 SAFETY**

- 3 Precautions before start-up
  - 4 Important safety instructions
  - 5 Protection against damage
  - 6 Precautions in case of appliance failure
  - 6 Protection against other hazards
- 

## **7 APPLIANCE DESCRIPTION**

- 7 Technical description
  - 9 Operating panel
- 

## **9 OPERATING THE HOB**

- 9 Display
  - 10 Ventilation
- 

## **10 STARTING UP THE HOB**

- 10 Before first use
  - 10 Induction principle
  - 11 Touch control function
  - 11 Smart Slider function
  - 11 Switching the hob on/off
  - 12 Pot detection
  - 12 Residual heat display
  - 13 Booster function (power level)
  - 14 Timer
  - 15 Automatic preheating
  - 16 Stop & Go function
  - 16 Memory function
  - 17 Keep warm function
  - 17 Automatic bridge and bridge function (models 5I184251,5I194291)
  - 18 Child lock / locking the hob
  - 18 Grill function (models 5I184251,5I194291)
- 

## **19 COOKING RECOMMENDATIONS**

- 19 Cookware
- 20 Cookware size
- 21 Setting ranges

- 21 STARTING UP THE HOOD** (NOT FOR 5IZ34291)
  - 21 Blaupunkt Multi Control – unique connection between hob and hood
  - 22 Switching hood lighting on/off
  - 22 Selecting hood management mode
  - 23 Setting the ventilation power
  - 23 Booster function
  - 24 Default speed setting in semi-automatic mode
  - 24 Ventilation timer
- 

## **25 CLEANING AND MAINTENANCE**

---

## **25 WHAT TO DO IF**

---

## **27 ENVIRONMENTAL PROTECTION**

---

## **27 INSTALLATION INSTRUCTIONS**

---

## **29 ELECTRICAL CONNECTION**

# SAFETY

## PRECAUTIONS BEFORE START-UP

---

- Remove all parts of the packaging.
- The appliance may only be installed and connected by a qualified electrician. The manufacturer cannot be held responsible for damage caused by errors in installation or connection. Only use the appliance when it is installed.
- The appliance may only be used when it is erected and installed in a piece of furniture and a confirmed and adjusted work plan is used.
- This appliance may only be used for the household cooking and frying of food and is not intended for commercial purposes.
- Remove all labels and stickers from the glass.
- The appliance may not be modified.
- Do not use the hob as a work surface or storage area.
- Safety is only guaranteed if the appliance is connected to a protective conductor that complies with the applicable regulations.
- The appliance may not be connected to the power supply via an extension cable.
- The appliance may not be used over a dishwasher or tumble dryer: the water vapours released could damage the electronics.
- Do not switch on the appliance using an external timer or a separate remote control.
- **CAUTION:** The cooking process must be monitored. A short-term cooking process must be constantly monitored.

# GENERAL SAFETY INSTRUCTIONS

---

- Switch off the cooking zones after each use.
- Overheated fats and oils ignite quickly. If you prepare dishes in fat or oil (e.g. chips), you should observe the cooking process.
- When you cook and fry, the cooking zones become hot. For this reason, protect yourself from burns while and after using the appliance.
- Ensure that no electrical cable from a freestanding or built-in appliance comes into contact with the panel or the hot cooking zone.
- Magnetic objects such as credit cards, diskettes, pocket calculators, etc. must not be in the immediate vicinity of the appliance when it is switched on. Their function could be impaired.
- Metal objects such as knives, forks, spoons and pot lids should not be placed on the hob as they could become hot.
- In general, do not place any metal objects (e.g. spoons, pot lids, etc.) on the induction surface, as they may heat up during operation.
- Never cover the cooking surface with a cloth or protective foil; these could become very hot and catch fire.
- This appliance can be used by children from the age of 8 years and above and persons with reduced physical, sensory or mental abilities or a lack of experience and knowledge if they are supervised or if they are instructed in the safe use of the appliance and understand the resulting hazards.
- Children may not play with the appliance.
- Cleaning and user maintenance may not be carried out by children without supervision.

## PROTECTION AGAINST DAMAGE

---

- Do not use any pots or pans with unpolished or damaged bases (e.g. made of cast iron). These can scratch the glass ceramic panels.
- Note that grains of sand can also cause scratches.
- Glass ceramic is insensitive to temperature shocks and very resistant, but it is not unbreakable. Especially pointed and hard objects that fall onto the cooking surface can damage them.
- Do not knock pots and edges against the panel.
- Do not use the cooking zones with empty cookware.
- Avoid placing sugar, plastic or aluminium foil on the hot cooking zones. These materials melt, stick firmly and can therefore lead to cracks, fractures or other permanent changes in the panel when cooling down. If they still get onto the hot cooking zones, please switch off the appliance and remove these substances while they are still hot. As the cooking zones are hot, there is a risk of burns.
- Do not place any objects on the cooking zone.
- Never place hot cookware on the control unit. The electronics under the glass could be damaged.
- If there is a drawer under the built-in appliance, make sure there is a minimum distance of 2 cm between the underside of the appliance and the contents of the drawer, otherwise the ventilation of the appliance is not guaranteed.
- No flammable objects (e.g. aerosol cans) may be stored in this drawer. Any cutlery trays in the drawer must be made of heat-resistant material.
- Do not heat closed containers (e.g. tins) on the cooking zones. The containers or tins can burst due to the resulting excess pressure, resulting in a risk of injury!

## PRECAUTIONS IN CASE OF APPLIANCE FAILURE

---

- If an error is detected, the appliance must be switched off and disconnected from the mains.
- If breaks, fissures or cracks occur on the glass: Immediately switch off the hob, unscrew or remove the hob fuse, and contact our customer service or your specialist retailer.
- Repairs to the appliance may only be carried out by qualified personnel.
- **WARNING:** If the glass surface is cracked, switch off the appliance to avoid the risk of electric shock.

## PROTECTION AGAINST OTHER HAZARDS

---

- Make sure that the cookware is always centred on the cooking zone. The base of the pan must cover as much of the cooking zone as possible.
- For persons with a pacemaker: an electromagnetic field is generated near the appliance when it is switched on, which could possibly affect the pacemaker. In case of doubt, please contact the manufacturer of the pacemaker or your doctor.
- Do not use cookware made of aluminum or plastic: it could melt on the hot cooking zones.
- **NEVER** try to extinguish a fire with water. Switch the device off and then cover the flame, e.g. with a lid or a fire blanket.

### WARNING

**The use of pots of poor quality or of an adapter disc for induction will lead to a premature termination of the warranty. The manufacturer accepts no liability for damage that may occur on or near the hob.**

# APPLIANCE DESCRIPTION

## TECHNICAL DESCRIPTION

Type	5IE64252	5IE84252	5II84251	5II94291	5IB64211	5IZ34291
Total power	7400W	7400 W	7400 W	7400 W	6700 W	3700 W
Energy consumption of the hob EChob**	180 Wh/kg	180 Wh/kg	173.4 Wh/kg	175.3 Wh/kg	180.7 Wh/kg	177.3 Wh/kg
<b>Front left cooking zone</b>	Ø 200 mm	Ø 160 mm	210x190mm	210x190mm	Ø 200 mm	Ø 160 mm
Minimum pot base diameter	Ø 110 mm	Ø 90 mm	Ø 110 mm	Ø 110 mm	Ø 110 mm	Ø 90 mm
Nominal power*	2300 W	1400 W	2100 W	2100 W	2300 W	1400 W
Booster power*	3000 W	2100 W	3000 W	3000 W	3000 W	2100 W
Standardised cookware category**	C	A	C	C	C	A
Energy consumption ECcw**	182.9 Wh/kg	191.8 Wh/kg	159.5 Wh/kg	159.5 Wh/kg	182.9 Wh/kg	191.8 Wh/kg
<b>Rear left cooking zone</b>	Ø 160 mm	Ø 200 mm	210x190mm	210x190mm	Ø 160 mm	Ø 160 mm
Minimum pot base diameter	Ø 90 mm	Ø 110 mm	Ø 110 mm	Ø 110 mm	Ø 90 mm	Ø 90 mm
Nominal power*	1400 W	2300 W	2100 W	2100 W	1400 W	1400 W
Booster power*	2100 W	3000 W	3000 W	3000 W	2100 W	2100 W
Standardised cookware category**	A	C	C	C	B	B
Energy consumption ECcw**	191.8 Wh/kg	182.9 Wh/kg	159.5 Wh/kg	159.5 Wh/kg	162.7 Wh/kg	162.7 Wh/kg
<b>Rear right cooking zone</b>	Ø 200 mm	Ø 200 mm	210x190mm	210x190mm	-	-
Minimum pot base diameter	Ø 110 mm	Ø 110 mm	Ø 110 mm	Ø 110 mm	-	-
Nominal power*	2300 W	2300 W	2100 W	2100 W	-	-
Booster power*	3000 W	3000 W	3000 W	3000 W	-	-
Standardised cookware category**	C	C	B	B	-	-
Energy consumption ECcw**	182.9 Wh/kg	182.9 Wh/kg	188 Wh/kg	188 Wh/kg	-	-



<b>Front right cooking zone</b>	Ø 160 mm	Ø 160 mm	210x190mm	210x190mm	Ø 250 mm	-
Minimum pot base diameter	Ø 90 mm	Ø 90 mm	Ø 110 mm	Ø 110 mm	Ø 110 mm	-
Nominal power*	1400 W	1400 W	2100 W	2100 W	2300 W	-
Booster power*	2100 W	2100 W	3000 W	3000 W	3000 W	-
Standardised cookware category**	B	B	A	A	D	-
Energy consumption EC <sub>cw</sub> **	162.7 Wh/kg	162.7 Wh/kg	186.4 Wh/kg	186.4 Wh/kg	196.5 Wh/kg	-
<b>Central cooking zone</b>	-	-	-	Ø 200 mm	-	-
Minimum pot base diameter	-	-	-	Ø 110 mm	-	-
Nominal power*	-	-	-	2300 W	-	-
Booster power*	-	-	-	3000 W	-	-
Standardised cookware category**	-	-	-	C	-	-
Energy consumption EC <sub>cw</sub> **	-	-	-	182.9 Wh/kg	-	-

\* These outputs may vary depending on the shape, size and quality of the pots.

\*\* calculated on the basis of the method for measuring the functional properties (EN 60350-2).

# OPERATING PANEL

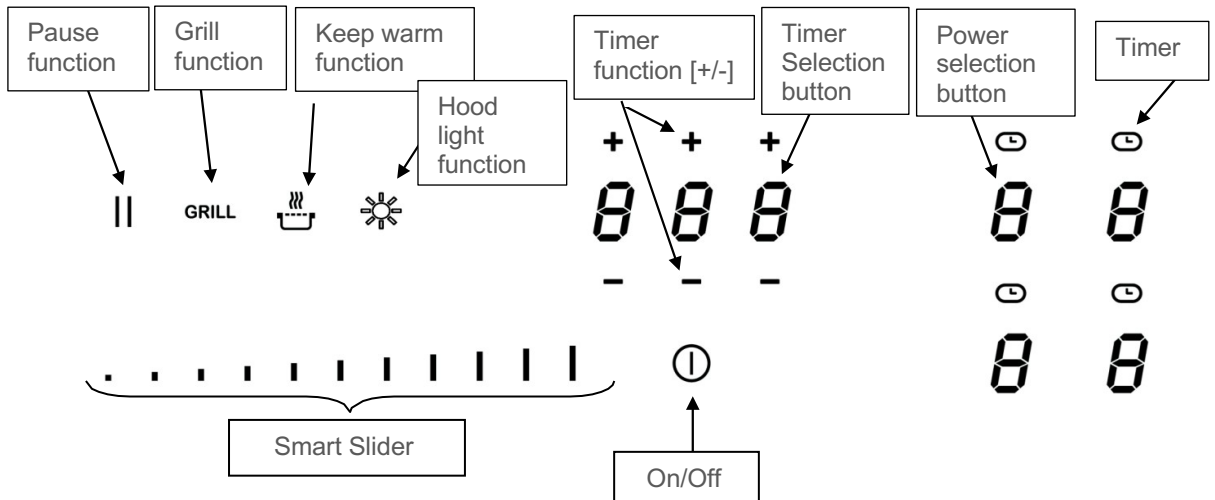

# OPERATING THE HOB

## DISPLAY

Display	Name	Description
0	Zero	The hob is activated
1...9	Power level	The power setting
<u>U</u>	No pot detection	Pot not in place or not suitable
A	Automatic preheating	Maximum power + preheating
E	Error display	Electronics error
H	Residual heat	Hob is hot
P	Booster	Booster power is activated
U	Keep warm function	With this function, food is kept warm at 70°C.
	Pause	The hob is on pause
□	Bridge	Two cooking zones can be combined into one cooking zone
<b>GRILL</b>	Grill function	The grill function is activated
	Hood – Manual operation	Ventilation takes place in manual mode
	Hood – Semi-automatic operation	Ventilation takes place in semi-automatic mode
	Hood – Automatic operation	Ventilation takes place in automatic mode

## VENTILATION

---

The fan works automatically. It starts at low speed as soon as the values released by the electronics exceed a certain threshold.

The higher speed is activated when the induction hob is used intensively. The fan reduces its speed and switches off automatically as soon as the electronics have cooled down sufficiently.

## STARTING UP THE HOB

### BEFORE FIRST USE

---

First clean your appliance with a damp cloth and then rub it dry with a clean cloth. Do not use any cleaning agent, which could cause a bluish tint on the glazed surface.

### INDUCTION PRINCIPLE

---

Under each cooking zone is an induction coil. When the cooking zone is switched on, the induction coil generates a variable electromagnetic field. The magnetic field generates inductive currents in the base of the pot, which must be magnetic. As a result, the base of the pot, which is located on the heating zone, heats up. The cooking zone heats up only indirectly through the heat emitted by the pot.

#### Induction cooking zones only work with magnetic cookware:

- Suitable induction cookware with a magnetic base such as: cast iron, steel, enamelled steel, stainless steel with a magnetic base.
- Unsuitable induction cookware: copper, aluminium, glass, wood, earthenware, ceramic, non-magnetic stainless steel.

The induction cooking zone is automatically adjusted to the size of the cookware. The cookware must not fall below a certain base diameter, otherwise the induction will not activate. Each pot base diameter must have a minimum size depending on the size of the cooking zone.

If the cookware is not suitable for induction, the [ U ] display will appear.

## TOUCH CONTROL FUNCTION

---

The hob is controlled by sensor buttons. These react to gentle touches of the glass with the finger. If you touch the buttons for about one second, the control commands are executed. Each reaction of the control buttons is acknowledged with an acoustic and/or visual signal.

For general use, only press one button at a time.

## SMART SLIDER FUNCTION

---

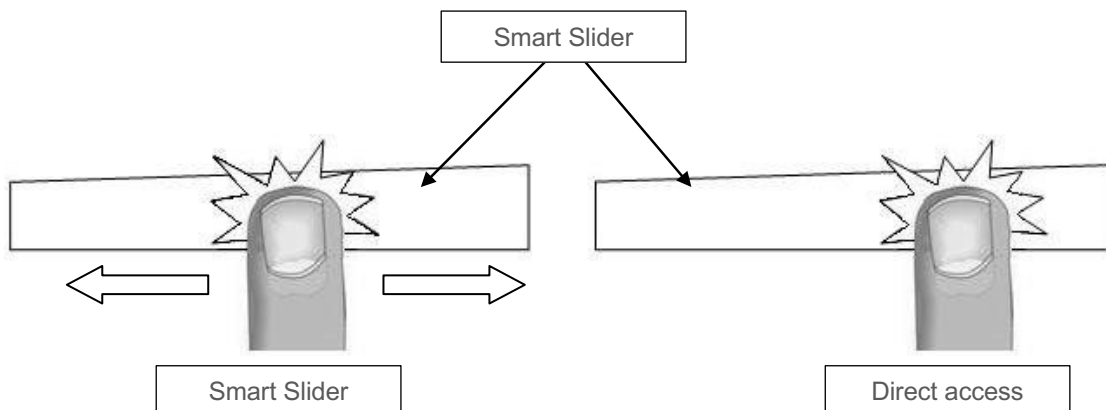

To select the power level using the SMART SLIDER, move your finger on the SLIDER ZONE. The desired performance can also be selected directly by touching the respective level.



## SWITCHING THE HOB ON/OFF

---

First switch on the hob and then the cooking zone.

<b>Hob: switch on/ switch off:</b>		
<b>Operation</b>	<b>Operating panel</b>	<b>Display</b>
Switch on	Press [  ] for 2 sec.	Press [0]
Switch off	Press [  ] for 2 sec.	None of [H]

Switch cooking zone on/off:		
Operation	Operating panel	Display
Increase power	Slide your finger over the Smart Slider	[ 1 ] to [ P ]
Switch off	Slide your finger over the Smart Slider	[ 0 ] or [ H ]

If no further input is made, the hob will switch off after approx. 20 seconds for safety reasons.

## POT DETECTION

---

For greater comfort and simplicity, this hob is equipped with a control system.

Switch on the hob and place a pot on the hob. The intuitive operation will automatically detect the pot or will display the [ 0 ] symbol above the Smart Slider to be used. You can now adjust the cooking level as desired.

The pot detection feature ensures complete safety.

### The induction system will not work:

- If there is no cookware on the cooking zone or if a pot unsuitable for induction is used. In this event, the power level cannot be increased and the [ U ] symbol will appear on the display. The [ U ] will disappear when a pot is placed on the cooking zone.
- If the pot is removed from the cooking zone during cooking, the cooking zone will immediately switch off and the [ U ] sign will appear in the display. The [ U ] will disappear when a pot is placed back on the cooking zone. The cooking zone then resumes at the previously set power level.

After use, switch off the cooking zone so that the [ U ] symbol no longer appears in the display.

## RESIDUAL HEAT DISPLAY

---

After the cooking zones or hob have been switched off, the residual heat of the cooking zones that are still hot is displayed with an [ H ]. The [ H ] will disappear if the cooking zones can be touched safely. As long as the residual heat display is lit, the cooking zones should not be touched and no heat-sensitive objects should be placed on them: **Risk of burns!**

## BOOSTER FUNCTION (POWER LEVEL)

---

All cooking zones are equipped with a booster function, i.e. with power amplification. The booster function is displayed with [ P ].

If they are switched on, these cooking zones operate for a period of 10 minutes. This high power is intended to enable you to do things like quickly heating large quantities of water, to boil water for pasta for example. After the appliance has automatically switched back after 10 minutes, you should **not switch back to the booster**. The appliance could overheat and will trigger a safety shutdown.

Switching booster on/off:		
Operation	Operating panel	Display
Switch on booster	Slide your finger over the Smart Slider or press the end immediately	[ P ]
Switch off booster	Slide your finger over the Smart Slider or press the end immediately	[ 9 ] to [ 0 ]

Management of the maximum power:	
The hob is equipped with a maximum power level. To ensure that this maximum power is not exceeded, the electronics automatically reduce the cooking level of another cooking zone when the booster function is activated. This cooking zone will then display the reduced power [ 9 ] by flashing.	
Selected cooking zone	Other cooking zone (e.g.: Power level 9)
[ P ] lights up	[ 9 ] is reduced to [ 6 ] or [ 8 ] and flashes

# TIMER

With the integrated timer, a cooking time of 1 to 999 minutes can be set on all four cooking zones. Each cooking zone can have a different setting.

<b>Activating or changing the duration:</b>		
<b>Operation</b>	<b>Operating panel</b>	<b>Display</b>
Select cooking zone	Press the corresponding cooking zone button	
Select power	Slide your finger over the Smart Slider	[ 1 ] to [ P ]
Select timer	Press [  ]	The display of the selected cooking zone will light up
Reduce time	Press [ - ] for the timer	[ 60 ] ...
Increase time	Press [ + ] for the timer	Time in min. will increase

After a few seconds, the flashing will stop. The duration is activated and the time lapse begins.

<b>Switching off the timer:</b>		
<b>Operation</b>	<b>Operating panel</b>	<b>Display</b>
Select timer	Press [  ]	The display of the selected cooking zone will light up
Switch off timer	Press [ - ] to [ 000 ]	[ 000 ]

If several timers are running, please repeat the procedure.

<b>Timer as egg timer:</b>		
The timer functions independently of the cooking zones and switches off as soon as one cooking zone is in operation. The process is carried out even if the hob is switched off.		
<b>Operation</b>	<b>Operating panel</b>	<b>Display</b>
Switch on the hob	Press [  ] for 2 sec.	[ 0 ]

Select timer	Press [ 000 ]	[ 000 ]
Reduce time	Press [ - ] for the timer	[ 60 ] ...
Increase time	Press [ + ] for the timer	Time in min. will increase

After a few seconds, the flashing will stop. The duration is activated and the time lapse begins.

#### Automatic switch off:

When the programmed cooking time has elapsed, [ 000 ] will flash and an acoustic signal will be given.

To switch off the signal tone and flashing, simply press the [ - ] or [ + ] button.

## AUTOMATIC PREHEATING

All cooking zones are equipped with automatic preheating. When the automatic preheating system is activated, the cooking zone automatically heats up at maximum power and then switches back to the cooking level you have selected. The preheating time depends on the selected continuous cooking level.

#### Activating the automatic preheating feature:

Operation	Operating panel		Display
Select power (e. g. « 7 »)	Slide your finger over the Smart Slider and remain for 3s		[ 7 ] flashes with [ A ]
	<b>Set continuous cooking level</b>	<b>Automatic preheating Time (min:sec)</b>	
	1	00:40	
	2	01:12	
	3	02:00	
	4	02:56	
	5	04:16	
	6	07:12	
	7	02:00	
	8	03:12	
	9	- : -	



Switching off the automatic preheating feature:		
Operation	Operating panel	Display
Select power	Slide your finger over the Smart Slider	[ 0 ] to [ 9 ]

## STOP & GO FUNCTION

---

With this feature, you can temporarily interrupt the cooking process and restart with the same settings.

Switching Stop & Go function on/off:		
Operation	Operating panel	Display
Switch on Stop & Go	Press [ II ] for 2s	[ II ] on displays
Switch off Stop & Go	Press [ II ] for 2s	Flashing Smart Slider
	Press the flashing Smart Slider	Former settings

## MEMORY FUNCTION

---

After switching off the hob, the last settings remain stored. You can reactivate these values using the memory function. The following settings can be reactivated using the memory function:

- Power levels of the cooking zones.
- Timer settings of the cooking zones.



### Settings of the automatic preheating function Calling up the memory function:

- Switch on hob (Press [  ] for 2 sec.)
- Press [ II ] within 6 seconds.
- The values of the last settings are reactivated.

## KEEP WARM FUNCTION

---





With this function, food is kept warm at 70 °C. This function prevents overflow and burning.

Switching on and off:		
Operation	Operating panel	Display
Switch on	Press 	[ U ]
Switch off	Press 	[ 0 ]

## AUTOMATIC BRIDGE AND BRIDGE FUNCTION (MODELS 5II84251,5II94291)

---

This function allows two cooking zones to be linked together for a single cooking process.

Process	Operating panel	Display
Switch on the hob	Press  for 2 sec.	[ 0 ]
Switch on bridge	Place a pot on one of the two cooking zones to be bridged and press the corresponding selection buttons	[ 0 ] and 
	or place a large pan on both of the zones you wish to use with this function	 will flash 
Increase power	Slide to the right over the Smart Slider that shows the power	[ 1 ] to [ P ]
Switch off bridge	Press the two desired zones	[ 0 ]

## CHILD LOCK / LOCKING THE HOB

---

To prevent the cooking zone setting from being altered, e.g. when cleaning the glass, the operating buttons (except the [  ] button) can be locked.

Activating the lock:		
Operation	Operating panel	Display
Switch on the hob	Press [  ] for 2 sec.	[ 0 ]
Switch on lock	Hold the button of a cooking zone for 3s. Then place your finger on the Smart Slider and slide your finger <b>from left to right</b>	Light on
Switch off lock	Hold the button of a cooking zone for 3s. Then place your finger on the Smart Slider and slide your finger <b>from right to left</b>	Light off

## GRILL FUNCTION (MODELS 5II84251,5II94291)

---

This function allows optimum use of the Blaupunkt griddle / Teppan Yaki plate. By bridging two cooking zones and using a suitable power level, this feature guarantees a pure indoor grilling pleasure. You can find the right accessories in our online shop at [www.blaupunkt-einbaugeräte.com](http://www.blaupunkt-einbaugeräte.com) or from your specialist retailer.

Switching the grill function on/off:		
Operation	Operating panel	Display
Switch on grill function	Press [ GRILL ]	[  ]
Switch off grill function	Press [ GRILL ]	[ 0 ]

<b>Operating time limit:</b>	
The hob has an automatic operating time limit. The continuous operating time of each cooking zone depends on the selected cooking level. A precondition is that no setting changes are made to the cooking zone during the period of use. The cooking zone is switched off once the operating time limit has responded.	
<b>Set cooking level</b>	<b>Operating time limit (hours:min)</b>
1	08:36
2	06:42
3	05:18
4	04:18
5	03:30
6	02:18
7	02:18
8	01:48
9	01:30

# COOKING RECOMMENDATIONS

## COOKWARE

### Suitable materials:

Steel, enamelled steel, cast iron, stainless steel with magnetic base, aluminium with magnetic base

### Unsuitable materials:

Aluminium and stainless steel without magnetic base, copper, brass, glass, earthenware, porcelain

Check with the manufacturer's instructions to determine whether the cookware is suitable for induction.

### To check the induction compatibility of pots:

- Fill the cookware with some water and place them on the induction cooking zone. Switch on the cooking zone at power level [ 9 ]. This water must heat up in a few seconds.
- Hold a magnet against the base of the cookware. If the magnet sticks, the cookware is suitable.

Certain pans can make a noise when placed on an induction cooking zone. This noise does not cause any interference with the appliance and has no influence on the cooking process.

The properties of the base of the cookware can influence the uniformity of the cooking result.

Only use pots and pans with a smooth base. Otherwise, rough pot or pan bases could scratch the glass ceramic panel.

Use pans with straight edges if possible. When using pans with sloping edges, induction also acts in the edge area of the pan. This can discolour the edge of the pan.

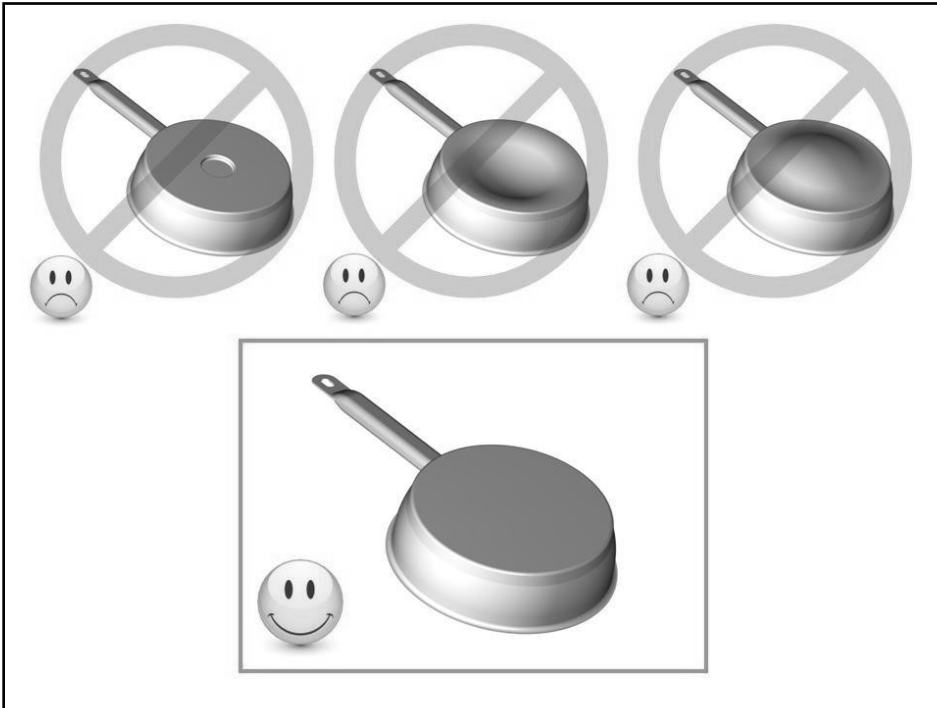

## **COOKWARE SIZE**

---

Up to a certain limit, the cooking zones automatically adjust to the size of the base of the pot. The cookware must not fall below a certain base diameter, otherwise the induction will not activate. Always centre the pot in the middle of the cooking zone to achieve the best possible efficiency.

## SETTING RANGES

---

(these data are approximate values)

1 to 2	Melting, heating	Sauces, butter, chocolate, gelatin, pre-cooked dishes
2 to 3	Swelling, defrosting, keeping warm	Rice, pudding, sugar syrup, dried vegetables, fish, frozen products
3 to 4	Steaming	Vegetables, fish, meat
4 to 5	Steaming, swelling, defrosting	Steamed potatoes, soups, pasta, fresh vegetables
6 to 7	Preheating, continued cooking	Goulash, roulades, sausage, hard-boiled eggs
7 to 8	Gentle frying	Potatoes, fish, schnitzel, fried sausage, fried eggs
9	Bake, roast, boil water	Steaks, omelets, fried dishes, water
P	Cooking	Large quantities of water

## STARTING UP THE HOOD (NOT FOR 5IZ34291)

### Blaupunkt Multi Control – unique connection between hob and hood

#### Calling up the user menu

Press the ON / OFF button a second time within 3 seconds after switching on. The "Pause" (||) button will flash. Keep this button pressed while simultaneously pressing all cooking zones clockwise (starting with the left front).

#### User menu «U9»

Select "U9" using the "Slider". The display will show 0 and 1 as available options. 0 is the default setting and means that the connection is deactivated.



Set the parameter "U9" to 1 to start the pairing process.

Press the On/Off button to save the setting and exit the pairing process. The Bluetooth connection will switch from pairing mode to normal mode.

## SWITCHING HOOD LIGHTING ON/OFF

---

This function switches the hood light on or off.

Operation	Operating panel	Display
Switch on hob	Press [  ] for 2 sec.	[ 0 ]
Switch on hood lighting	Press [  ] button	
Switch off hood lighting	Press [  ] button	

## SELECTING HOOD MANAGEMENT MODE

---









**Three operating modes are available for the hood:**

Manual mode: Manual setting of the ventilation intensity from the hob.

Semi-automatic mode: Ventilation starts automatically at a fixed intermediate level as soon as a cooking zone is activated (minimum level if no pans are detected). Ventilation is switched off when the cooking zones or hob are switched off (if the ventilation timer is not activated).

Automatic mode: The intensity of the ventilation automatically adjusts to the levels of the cooking zones.

When the hob is switched on, the last mode selected before it was switched off is activated.

Operation	Operating panel	Display
Switch on hob	Press [  ] for 2 sec.	[  ]
Switch from semi-automatic to automatic	Press [  ] for 3 sec.	[  ]
Switch from automatic to manual	Press [  ] for 3 sec.	[  ]
Switch from manual to semi-automatic	Press [  ] for 3 sec.	[  ]

## SETTING THE VENTILATION POWER

---

The ventilation speed can be set in manual and semi-automatic mode. If an adjustment is made in the automatic mode, the management mode will switch to manual mode.

Operation	Operating panel	Display
Select ventilation	Press ventilation display	[ ..    ]
Increase power	Press the right side of the illuminated "Smart Slider"	
Decrease power	Press the left side of the illuminated "Smart Slider"	
Switch off ventilation	Press the right side of the illuminated slider for 3 sec.	

## BOOSTER FUNCTION

---

The booster function increases the ventilation power. When the function is activated, the ventilation will operate for 6 minutes at a significantly higher power level.

The booster is used, for example, to vent large quantities of vapour.



Operation	Operating panel	Display
Select ventilation	Press ventilation display	[ ..    ]
Ventilation booster	Press the right side of the illuminated slider for 3 sec.	

The booster function can be stopped manually by stopping the ventilation or reducing the ventilation speed.







## DEFAULT SPEED SETTING IN SEMI-AUTOMATIC MODE





The default speed used in semi-automatic mode can be adjusted if it is changed manually on the selected cooking zone within 10 seconds after starting ventilation.

Operation	Operating panel	Display
Switch on hob	Press [①] for 2 sec.	[ 0 ] to [  ]
Select cooking zone	Press a cooking zone display	[ 0 ]
Select power level	Press “Smart Slider”	[ 0 ] to [ P ]
Select ventilation	Press ventilation display	[  ]
Increase or reduce speed	Press the illuminated “Smart Slider”	[  ]

## VENTILATION TIMER

Your hood has a timed switch-off function, which allows you to run your ventilation 10 minutes before switching off. This function is particularly useful for removing vapour and any odours after cooking.

Switching on the ventilation timer:		
Operation	Operating panel	Display
Select ventilation	Press ventilation display	[  ] or [  ] or [  ]
Select timer	Press [  ]	Timer display on and display shows 10 min.

Switching off the ventilation timer:		
Operation	Operating panel	Display
Select ventilation	Press ventilation display	[  ] or [  ] or [  ]
Select timer	Press [  ]	Timer display off

# CLEANING AND MAINTENANCE

Before cleaning the hob after cooking, you should first allow it to cool down.

Otherwise there is a risk of burns. Clean the dirty hob regularly. Use a damp cloth and a small amount of cleaning agent. Then rub it dry with a clean cloth.

- The appliance must be switched off before cleaning.
- Cleaning the appliance with a steam cleaner or high-pressure cleaner is not permitted for safety reasons.
- Never use abrasive or aggressive cleaning agents such as grill and oven sprays, stain or rust removers, scouring powders or sponges with scratchy surfaces.
- Afterwards, rub the hob dry with a clean cloth.
- If things like sugar, plastic or aluminium foil accidentally get on the hob, you should switch off the hob as soon as possible and remove them immediately. Be very careful when doing so, as otherwise there is a risk of burns. Remove them immediately after switching off the cooking zones.

## WHAT TO DO IF...

### **The hob or cooking zones cannot be switched on:**

- The hob is incorrectly connected to the mains power.
- The fuse of the household installation is not inserted correctly or is defective.
- The hob is locked.
- The sensor buttons are covered with water or dirt.
- A pot or objects are covering the buttons.

### **The display shows [ U ]:**

- The cookware is not on the cooking zone.
- The cookware is not suitable for induction
- The diameter of the pot base is too small for this cooking zone.

### **The display shows [ E ]:**

- Disconnect the appliance from the mains and reconnect it.
- Call customer service.

### **One cooking zone or the entire cooking zone switches off:**

- The safety shutdown has been triggered.
- Someone forgot to turn off a cooking zone.
- Several sensor buttons are covered.

- The pot is empty and overheated.
- Due to overheating, the electronics have automatically reduced or automatically switched off the power.

**The cooling fan keeps running after it has been switched off:**

- This is not a fault; the fan continues to run until the appliance has cooled down.
- The fan switches off automatically.

**The automatic preheating function does not switch on:**

- The cooking zone is still hot [ H ]
- The maximum power level is switched on [ 9 ].

**Display [ U ]:**

- Refer to the chapter on the keep warm level.

**Display [ II ]:**

- Refer to the chapter on the Stop&Go function.

**The display shows  or [ Er03 ]:**

- An object or a liquid is covering the buttons. The display will disappear as soon as the buttons are released or cleaned.

**The display shows [ E2 ]:**

- The hob has overheated; let it cool down first and then turn it on again.

**The display shows [ E8 ]:**

- The air intake of the fan is clogged; please remove the things that are causing the interference.

**The display shows [ U400 ]:**

- The hob is not connected to the mains. Check the connection and turn on the hob.

**The display shows [ Er47 ]:**

- The hob is not connected to the mains. Check the connection and turn on the hob.

**If any of the above signs persist, please contact customer service.**

# ENVIRONMENTAL PROTECTION

The packaging materials are environmentally friendly and recyclable.

Electrical and electronic devices still contain valuable materials. However, they also contain harmful substances necessary for their function and safety.

- For this reason, never dispose of your old appliance in the residual waste.
- Instead, use the collection point provided by your local authority to return and recycle old electrical and electronic equipment.

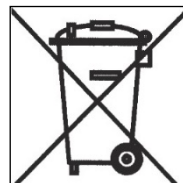

# INSTALLATION INSTRUCTIONS

Only an authorised specialist may carry out installation and connection. The user must ensure that the standards applicable in his place of residence are observed.

## Installing the seal

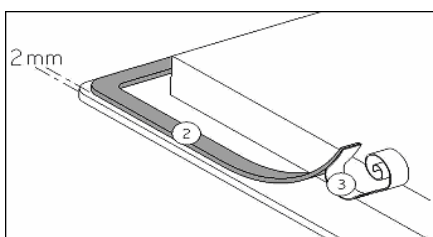

After removing the protective film (3), glue the seal (2) at a distance of 2 mm from the outer edge of the glass.

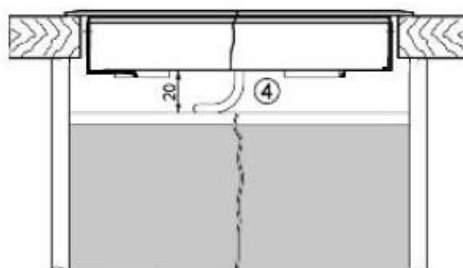
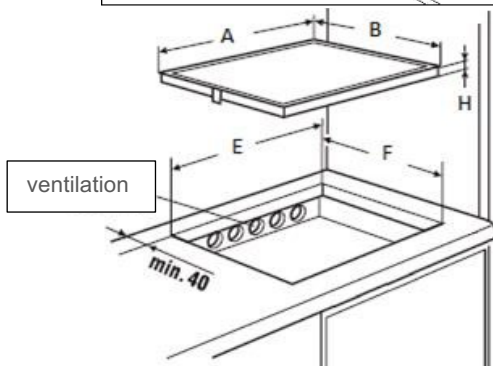

## Installation

### Insertion dimensions:

	A	B	E	F	H
5IE64252	590 mm	520 mm	560 mm	490 mm	52 mm
5IE84252	780 mm	520 mm	750 mm	490 mm	52 mm
5II84251	780 mm	520 mm	750 mm	490 mm	52 mm
5II94291	880 mm	520 mm	810 mm	490 mm	52 mm
5IB64211	590 mm	520 mm	560 mm	490 mm	52 mm
5IZ34291	300 mm	520 mm	270 mm	490 mm	52 mm

- **The distance from the cut-out to a wall and/or a piece of furniture must be at least 40 mm.**
- This appliance complies with type Y with regard to protection against fire hazards. Only appliances of this type may be installed on one side of adjacent tall cupboards or walls.  
**Caution: no furniture or appliances may be higher than the hob from the other side.**
- The worktop must be finished with heat-resistant adhesive (75 °C).
- The wall edging strips must be heat-resistant.
- The hob must not be installed above stoves without fans, dishwashers, washing or drying appliances.
- To ensure adequate ventilation of the electronics in the hob, **an air gap of 20 mm is required under the cavity.**
- If there is a drawer under the hob, no flammable objects, e.g. aerosol cans, may be stored in the drawer.
- The safety distance specified by the manufacturer must be maintained between the appliance and an extractor hood. If not specified, this distance must be at least 650 mm.
- It must be ensured that the connection cable of the hob is not exposed to any mechanical stress after installation, e.g. by a drawer.
- The cutting surfaces of worktops should be sealed with special paint, silicone rubber or casting resin to prevent swelling due to moisture. Ensure that the sealing tape supplied is carefully applied.
- **Never glue the hob with silicone!** It will then no longer be possible to remove the hob later without destroying it.
- Do not use any unsuitable safety grilles or protective devices for the hob. This can lead to accidents.

## Ventilation

- The rear wall of the base cabinet must be open in the area of the worktop cut-out to ensure an exchange of air.
- The distance between the induction hob and kitchen furniture or built-in appliances must be selected in such a way that adequate induction ventilation is ensured.
- Excessive heat development from below, e.g. from an oven without a cross-flow fan, must be avoided.
- If pyrolysis operations are carried out in built-in stoves, the induction hob may not be used.

## ELECTRICAL CONNECTION

- To connect the appliance to the power supply, you should consult a qualified electrician who is thoroughly acquainted with the regulations of the local electrical supply companies and who will carefully observe them.
- The contact protection of operationally insulated parts must be ensured after installation.
- Check the type label to see whether the required connection data correspond to those of the mains.
- It must be possible to disconnect all poles of the appliance from the mains using isolating devices. When switched off, there must be a contact clearance of 3 mm. Circuit breakers, fuses and contactors are considered suitable isolating devices.
- The installation must be protected by fuses. Electrical cables must be perfectly concealed by the installation.
- If the appliance is not equipped with an accessible plug, other means of disconnection must be taken into account for fixed installation in accordance with the installation instructions.
- The supply cable must be installed in such a way that it does not touch the hot parts of the hob.

### Caution!

This appliance is only designed for a power supply of 230V/400 V ~ 50/60 Hz. Always connect the protective conductor. Please observe the wiring diagram.

The connection box is located on the bottom of the appliance. To open the casing, use a screwdriver and insert it into the slots provided. Tighten the screws in the connecting terminal block after 4 weeks.

**Models 3 and 4 heating zones: 5IE64252, 5IE84252, 5II84251, 5IB64211**

Mains	Connection	Diameter	Cable	Fuse
230V~50/60Hz	1 phase + N	3 x 2.5 mm <sup>2</sup>	H 05 VV - F H 05 RR - F	25 A *
400V~ 50/60Hz	2 phases + N	4 x 1.5 mm <sup>2</sup>	H 05 VV - F H 05 RR - F	16 A *

( \*) as per standard EN 60 335-2-6

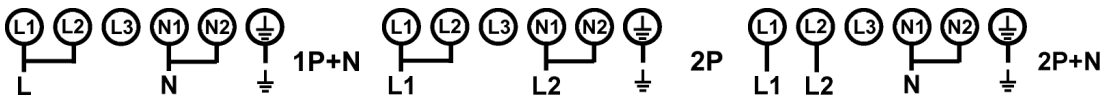

**Connecting the hob**

For the various connection options, use the brass terminal bridges located in the casing.

**Single-phase connection 230V~1P+N:**

Place a terminal bridge between terminals L1 and L2, then between terminals N1 and N2. Connect the earthing to the « earth » terminal, the neutral to terminal N1 or N2, and phase L to terminal L1 or L2.

**Two-phase connection 400V~2P+N:**

Place a terminal bridge between terminal N1 and N2. Connect the earthing to the « earth » terminal, the neutral to terminal N1 or N2, phase L1 to terminal L1 and phase L2 to terminal L2.

**Model 5 heating zones: 5II94291**

Mains	Connection	Diameter	Cable	Fuse
230V~50/60Hz	1 phase + N	3 x 2.5 mm <sup>2</sup>	H 05 VV - F H 05 RR - F	25 A *
400V~ 50/60Hz	2 phases + N	4 x 1.5 mm <sup>2</sup>	H 05 VV - F H 05 RR - F	16 A *
400V~ 50/60Hz	3 phases + N	5 x 1.5 mm <sup>2</sup>	H 05 VV - F H 05 RR - F	16 A *

( \*) as per standard EN 60 335-2-6

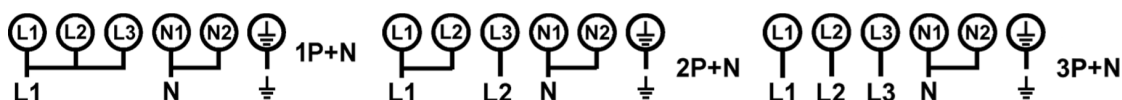

## Connecting the hob

For the various connection options, use the brass terminal bridges located in the casing.

### Single-phase connection 230V~1P+N:

Place a terminal bridge between terminals L1 and L2, then between terminals L2 and L3 and then between terminals N1 and N2.

Connect the earthing to the « earth » terminal, the neutral to terminal N1 or N2, and phase L to terminal L1 or L2 or L3.

### Two-phase connection 400V~2P+N:

Place a terminal bridge between terminals L1 and L2, then between terminals N1 and N2.

Connect the earthing to the « earth » terminal, the neutral to terminal N1 or N2, phase L1 to terminal L1 or L2 and phase L2 to terminal L3.

### Three-phase connection 400V~3P+N:

Place a terminal bridge between terminal N1 and N2.

Connect the earthing to the « earth » terminal, the neutral to terminal N1 or N2, phase L1 to terminal L1, phase L2 to terminal L2 and phase L3 to terminal L3.

### Model 2 heating zones: 5IZ34291

Mains	Connection	Diameter	Cable	Fuse
230V~50/60Hz	1 phase + N	3 x 1.5 mm <sup>2</sup>	H 05 VV - F H 05 RR - F	16 A *

( \*) as per standard EN 60 335-2-6

**Caution! Insert the wires correctly and tighten the screws.**

**We are not responsible for incidents resulting from incorrect connections or non-existent or inadequate ground connections.**



# Service



[www.blaupunkt-einbaugeraete.com](http://www.blaupunkt-einbaugeraete.com)

 **00 800 32 289 000**

Deutschland/Germany  
[service.DE@blaupunkt-einbaugeraete.com](mailto:service.DE@blaupunkt-einbaugeraete.com)

Österreich/Austria  
[service.AT@blaupunkt-einbaugeraete.com](mailto:service.AT@blaupunkt-einbaugeraete.com)

Niederlande/Netherlands  
[service.NL@blaupunkt-einbaugeraete.com](mailto:service.NL@blaupunkt-einbaugeraete.com)

Belgien/Belgium  
[service.BE@blaupunkt-einbaugeraete.com](mailto:service.BE@blaupunkt-einbaugeraete.com)

Schweden/Sweden  
[service.SE@blaupunkt-einbaugeraete.com](mailto:service.SE@blaupunkt-einbaugeraete.com)

Frankreich/France  
[service.FR@blaupunkt-einbaugeraete.com](mailto:service.FR@blaupunkt-einbaugeraete.com)

Luxemburg/Luxembourg  
[service.LU@blaupunkt-einbaugeraete.com](mailto:service.LU@blaupunkt-einbaugeraete.com)

Schweiz/Switzerland  
[service.CH@blaupunkt-einbaugeraete.com](mailto:service.CH@blaupunkt-einbaugeraete.com)

Italien/Italy  
[service.IT@blaupunkt-einbaugeraete.com](mailto:service.IT@blaupunkt-einbaugeraete.com)

Spanien/Spain  
[service.ES@blaupunkt-einbaugeraete.com](mailto:service.ES@blaupunkt-einbaugeraete.com)

Großbritannien/Great Britain  
[service.GB@blaupunkt-einbaugeraete.com](mailto:service.GB@blaupunkt-einbaugeraete.com)

Malta/Malta  
[service.MT@blaupunkt-einbaugeraete.com](mailto:service.MT@blaupunkt-einbaugeraete.com)

 **1800 252 878 658**

Australien/Australia  
[CustomerCare@blaupunktAU.com](mailto:CustomerCare@blaupunktAU.com)

 **1800 209 2096**

Indien/India