



Instructions for installation and use

Built-in Microwave
5MA27500AU

PRECAUTIONS TO AVOID POSSIBLE EXPOSURE TO EXCESSIVE MICROWAVE ENERGY

(a) Do not attempt to operate this oven with the door open since this can result in harmful exposure to microwave energy. It is important not to break or tamper with the safety interlocks.

(b) Do not place any object between the oven front face and the door or allow soil or cleaner residue to accumulate on sealing surfaces.

(c) WARNING: If the door or door seals are damaged, the oven must not be operated until it has been repaired by a competent person.

ADDENDUM

If the apparatus is not maintained in a good state of cleanliness, its surface could be degraded and affect the lifespan of the apparatus and lead to a dangerous situation.

Specifications

Model:	5MA27500AU
Rated Voltage:	230-240V~50Hz
Rated Input Power(Microwave):	1550W
Rated Output Power(Microwave):	1000W
Rated Input Power(Grill):	1100W
Rated Input Power(Convection):	2300W
Oven Capacity:	34L
Turntable Diameter:	Ø 315mm
External Dimensions:	595x467.5x388mm
Net Weight:	Approx. 21.5kg

IMPORTANT SAFETY INSTRUCTIONS WARNING

To reduce the risk of fire, electric shock, injury to persons or exposure to excessive microwave oven energy when using your appliance, follow basic precautions, including the following:

1. Read and follow the specific: "PRECAUTIONS TO AVOID POSSIBLE EXPOSURE TO EXCESSIVE MICROWAVE ENERGY".
2. This appliance can be used by children aged from 8 years and above and persons with reduced physical, sensory or mental capabilities or lack of experience and knowledge if they have been given supervision or instruction concerning use of the appliance in a safe way and understand the hazards involved. Children shall not play with the appliance. Cleaning and user maintenance shall not be made by children unless they are older than 8 and supervised. Children less than 8 years of age shall be kept away unless continuously supervised.
3. Keep the appliance and its cord out of reach of children less than 8 years.
4. If the supply cord is damaged, it must be replaced by the manufacturer, its service agent or similarly qualified persons in order to avoid a hazard. (For appliance with type Y attachment)
5. **WARNING:** Ensure that the appliance is switched off before replacing the lamp to avoid the possibility of electric shock.

6. WARNING: It is hazardous for anyone other than a competent person to carry out any service or repair operation that involves the removal of a cover which gives protection against exposure to microwave energy.
7. WARNING: Liquids and other foods must not be heated in sealed containers since they are liable to explode.
8. When heating food in plastic or paper containers, keep an eye on the oven due to the possibility of ignition.
9. Only use utensils that are suitable for use in microwave ovens.
10. If smoke is emitted, switch off or unplug the appliance and keep the door closed in order to stifle any flames.
11. Microwave heating of beverages can result in delayed eruptive boiling, therefore care must be taken when handling the container.
12. The contents of feeding bottles and baby food jars shall be stirred or shaken and the temperature checked before consumption, in order to avoid burns.
13. Eggs in their shell and whole hard-boiled eggs should not be heated in microwave ovens since they may explode, even after microwave heating has ended.
14. The oven should be cleaned regularly and any food deposits removed.
15. Failure to maintain the oven in a clean condition could lead to deterioration of the surface that could adversely affect the life of the appliance and possibly result in a hazardous situation.

16. Only use the temperature probe recommended for this oven. (for ovens provided with a facility to use a temperature-sensing probe.)

17. The microwave oven must be operated with the decorative door open. (for ovens with a decorative door.)

18. This appliance is intended to be used in household and similar applications such as:

-staff kitchen areas in shops, offices and other working environments;

-by clients in hotels, motels and other residential type environments;

-farm houses;

-bed and breakfast type environments.

19. The microwave oven is intended for heating food and beverages. Drying of food or clothing and heating of warming pads, slippers, sponges, damp cloth and similar may lead to risk of injury, ignition or fire.

20. Metallic containers for food and beverages are not allowed during microwave cooking.

21. The appliance shall not be cleaned with a steam cleaner.

22. Care should be taken not to displace the turntable when removing containers from the appliance. (For fixed appliances and built-in appliances being used equal or higher than 900mm above the floor and having detachable turntables. But this is not applicable for appliances with horizontal bottom hinged door.)

23. The microwave oven is intended to be used built-in.
24. Steam cleaner is not to be used.
25. Surface of a storage drawer can get hot.
26. **WARNING:** The appliance and its accessible parts become hot during use. Care should be taken to avoid touching heating elements. Children less than 8 years of age shall be kept away unless continuously supervised.
27. During use the appliance becomes hot. Care should be taken to avoid touching heating elements inside the oven.
28. **WARNING:** Accessible parts may become hot during use. Young children should be kept away.
29. The appliance must not be installed behind a decorative door in order to avoid overheating. (This is not applicable for appliances with decorative door.)
30. **WARNING:** When the appliance is operated in the combination mode, children should only use the oven under adult supervision due to the temperatures generated.
31. Do not use harsh abrasive cleaners or sharp metal scrapers to clean the oven door glass since they can scratch the surface, which may result in shattering of the glass.

READ CAREFULLY AND KEEP FOR FUTURE REFERENCE

To Reduce the Risk of Injury to Persons Grounding Installation

DANGER

Electric Shock Hazard
Touching some of the internal components can cause serious personal injury or death. Do not disassemble this appliance.

WARNING

Electric Shock Hazard
Improper use of the grounding can result in electric shock. Do not plug into an outlet until appliance is properly installed and grounded.

This appliance must be grounded. In the event of an electrical short circuit, grounding reduces the risk of electric shock by providing an escape wire for the electric current. This appliance is equipped with a cord having a grounding wire with a grounding plug. The plug must be plugged into an outlet that is properly installed and grounded.

Consult a qualified electrician or serviceman if the grounding instructions are not completely understood or if doubt exists as to whether the appliance is properly grounded. If it is necessary to use an extension cord, use only a 3-wire extension cord.

1. A short power-supply cord is provided to reduce the risks resulting from becoming entangled in or tripping over a longer cord.
2. If a long cord set or extension cord is used:
 - 1)The marked electrical rating of the cord set or extension cord should be at least as great as the electrical rating of the appliance.
 - 2)The extension cord must be a grounding-type 3-wire cord.
 - 3)The long cord should be arranged so that it will not drape over the counter top or tabletop where it can be pulled on by children or tripped over unintentionally.

CLEANING

Be sure to unplug the appliance from the power supply.

1. Clean the cavity of the oven after using with a slightly damp cloth.
2. Clean the accessories in the usual way in soapy water.
3. The door frame and seal and neighbouring parts must be cleaned carefully with a damp cloth when they are dirty.
4. Do not use harsh abrasive cleaners or sharp metal scrapers to clean the oven door glass since they can scratch the surface, which may result in shattering of the glass.
5. Cleaning Tip---For easier cleaning of the cavity walls that the food cooked can touch: Place half a lemon in a bowl, add 300ml (1/2 pint) water and heat on 100% microwave power for 10 minutes. Wipe the oven clean using a soft, dry cloth.

UTENSILS

CAUTION

Personal Injury Hazard

It is hazardous for anyone other than a competent person to carry out any service or repair operation that involves the removal of a cover which gives protection against exposure to microwave energy.

See the instructions on "Materials you can use in microwave oven or to be avoided in microwave oven."

There may be certain non-metallic utensils that are not safe to use for microwaving. If in doubt, you can test the utensil in question following the procedure below.

Utensil Test:

1. Fill a microwave-safe container with 1 cup of cold water (250ml) along with the utensil in question.
2. Cook on maximum power for 1 minute.
3. Carefully feel the utensil. If the empty utensil is warm, do not use it for microwave cooking.
4. Do not exceed 1 minute cooking time.

Materials you can use in microwave oven

Utensils	Remarks
Browning dish	Follow manufacturer's instructions. The bottom of browning dish must be at least 3/16 inch (5mm) above the turntable. Incorrect usage may cause the turntable to break.
Dinnerware	Microwave-safe only. Follow manufacturer's instructions. Do not use cracked or chipped dishes.
Glass jars	Always remove lid. Use only to heat food until just warm. Most glass jars are not heat resistant and may break.
Glassware	Heat-resistant oven glassware only. Make sure there is no metallic trim. Do not use cracked or chipped dishes.
Oven cooking bags	Follow manufacturer's instructions. Do not close with metal tie. Make slits to allow steam to escape.
Paper plates and cups	Use for short-term cooking/warming only. Do not leave oven unattended while cooking.
Paper towels	Use to cover food for reheating and absorbing fat. Use with supervision for a short-term cooking only.
Parchment paper	Use as a cover to prevent splattering or a wrap for steaming.
Plastic	Microwave-safe only. Follow the manufacturer's instructions. Should be labeled "Microwave Safe". Some plastic containers soften, as the food inside gets hot. "Boiling bags" and tightly closed plastic bags should be slit, pierced or vented as directed by package.
Plastic wrap	Microwave-safe only. Use to cover food during cooking to retain moisture. Do not allow plastic wrap to touch food.
Thermometers	Microwave-safe only (meat and candy thermometers).
Wax paper	Use as a cover to prevent splattering and retain moisture.

Materials to be avoided in microwave oven

Utensils	Remarks
Aluminum tray	May cause arcing. Transfer food into microwave-safe dish.
Food carton with metal handle	May cause arcing. Transfer food into microwave-safe dish.
Metal or metal-trimmed utensils	Metal shields the food from microwave energy. Metal trim may cause arcing.
Metal twist ties	May cause arcing and could cause a fire in the oven.
Paper bags	May cause a fire in the oven.
Plastic foam	Plastic foam may melt or contaminate the liquid inside when exposed to high temperature.
Wood	Wood will dry out when used in the microwave oven and may split or crack.

SETTING UP YOUR OVEN

Names of Oven Parts and Accessories

Remove the oven and all materials from the carton and oven cavity.

Your oven comes with the following accessories:

- Glass tray 1
- Turntable ring assembly 1
- Instruction Manual 1

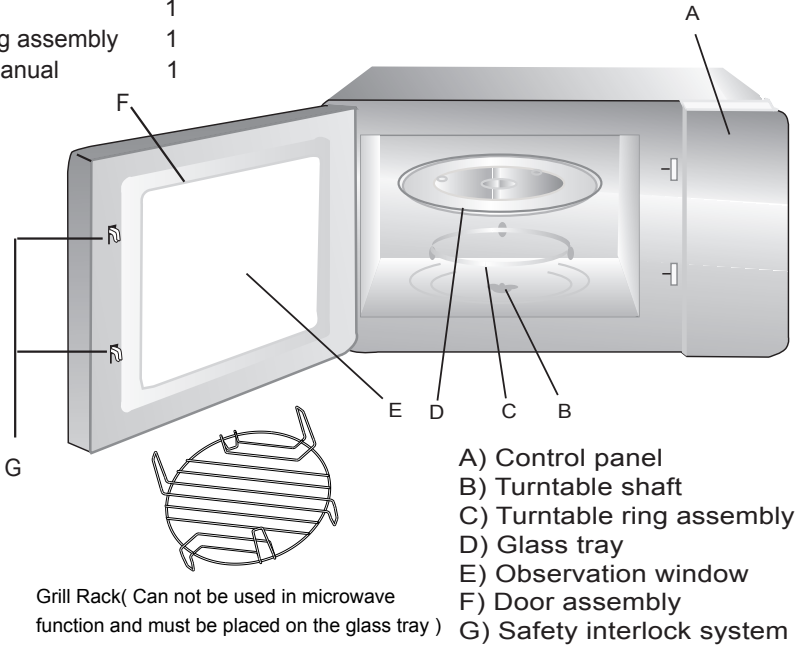

Grill Rack(Can not be used in microwave function and must be placed on the glass tray)

Turntable Installation

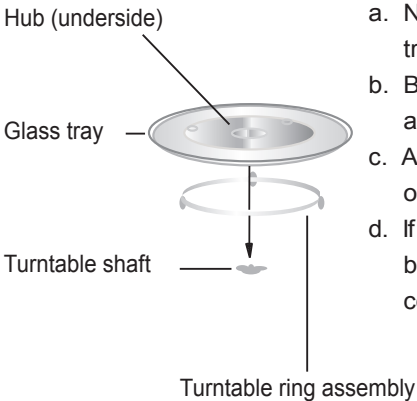

- a. Never place the glass tray upside down. The glass tray should never be restricted.
- b. Both glass tray and turntable ring assembly must always be used during cooking.
- c. All food and containers of food are always placed on the glass tray for cooking.
- d. If glass tray or turntable ring assembly cracks or breaks, contact your nearest authorized service center.

Installation and connection

- 1.This appliance is only intended for domestic use.
- 2.This oven is intended for built-in use only. It is not intended for counter-top use or for use inside a cupboard.
3. Please observe the special installation instructions.
- 4.The appliance can be installed in a 60cm wide wall-mounted cupboard.
- 5.The appliance is fitted with a plug and must only be connected to a properly installed earthed socket.
- 6.The mains voltage must correspond to the voltage specified on the rating plate.
- 7.The socket must be installed and connecting cable must only be replaced by a qualified electrician. If the plug is no longer to accessible following installation, an all-pole disconnecting device must be present on the installation side with a contact gap of at least 3mm.
- 8.Adapters, multi-way strips and extension leads must not be used. Overloading can result in a risk of fire.

The accessible surface may be hot during operation.



Installation Instructions

Please Read the Manual Carefully Before Installation

SCREW ———— 
TRIM-KIT PLASTIC COVER ———— 
COVER

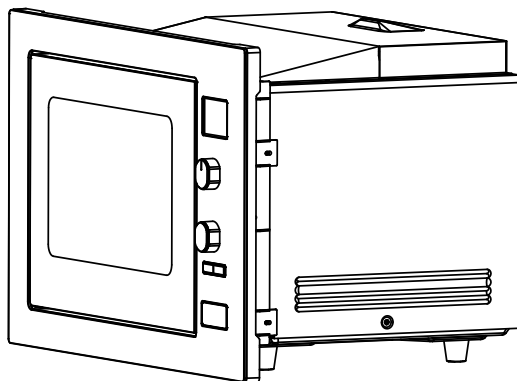

Please Note

Electrical connection

The oven is fitted with a plug and must be only connected to a properly installed earthed socket. In accordance with the appropriate regulations, the socket must only be installed and the connecting cable must only be replaced by a qualified electrician.

If the plug is no longer accessible following installation and all-pole isolating switch must be present on the installation side with a contact gap of at least 3mm.

A. Built-in furniture

The built-in cabinet shall not have a rear wall behind the appliance.

Minimum installation height is 85cm.

Do not cover ventilation slots and air intake points.

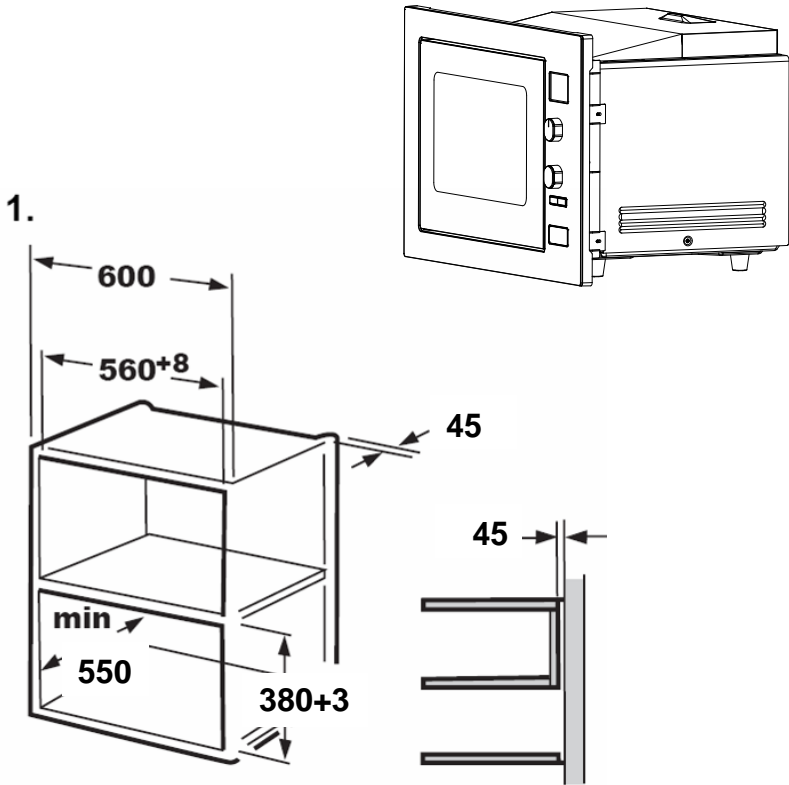

2.

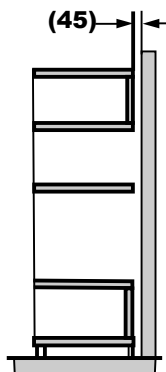
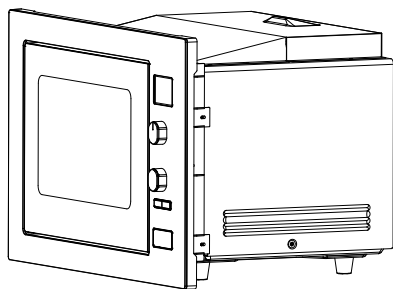
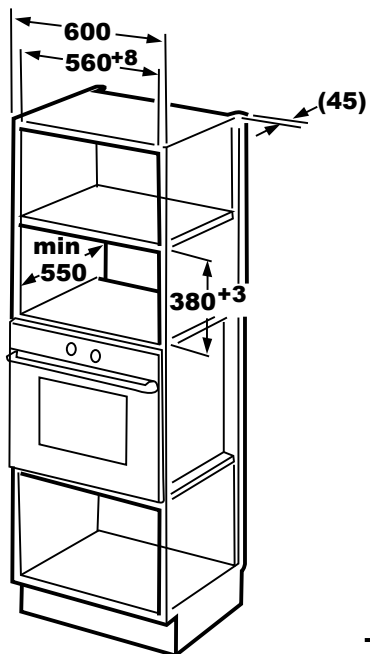

B. Install the Oven

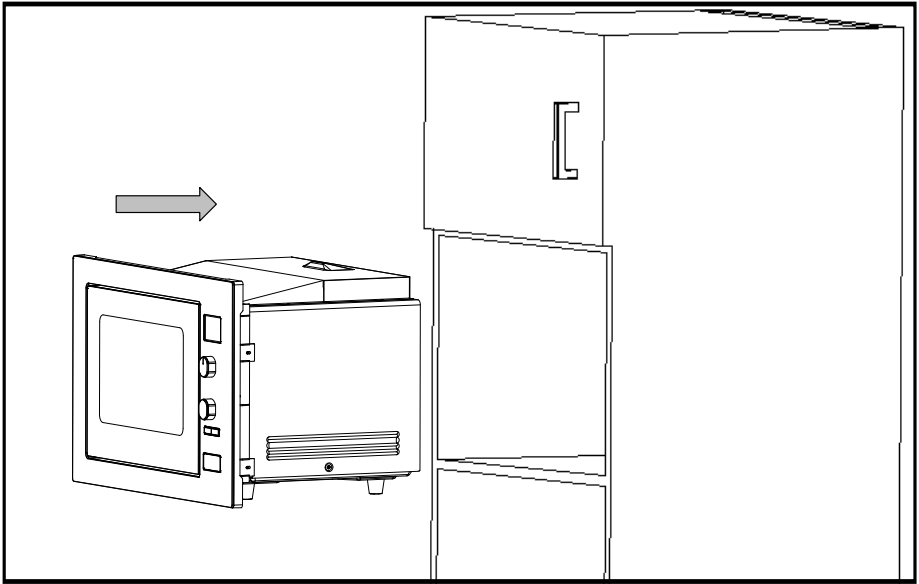

1. ● Do not trap or kink the power cord.
- Make sure that the oven is installed in the center of the cabinet.

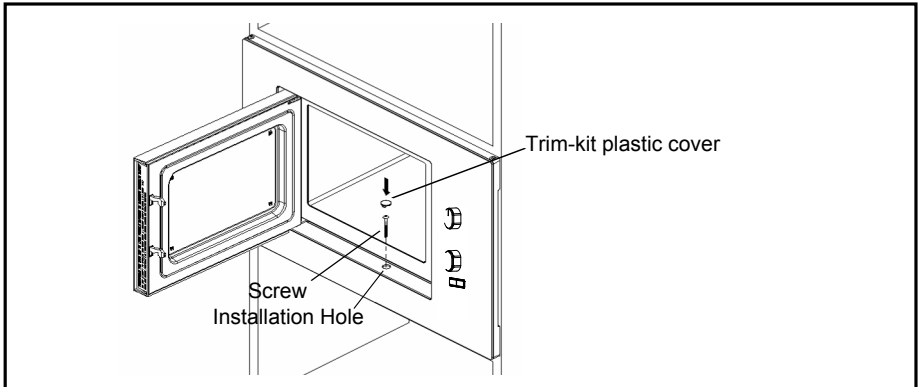

2. Open the door; fix the oven to the cabinet with SCREW at the INSTALLATION HOLE of TRIM KIT. Then fix the TRIM-KIT PLASTIC COVER to the INSTALLATION HOLE.



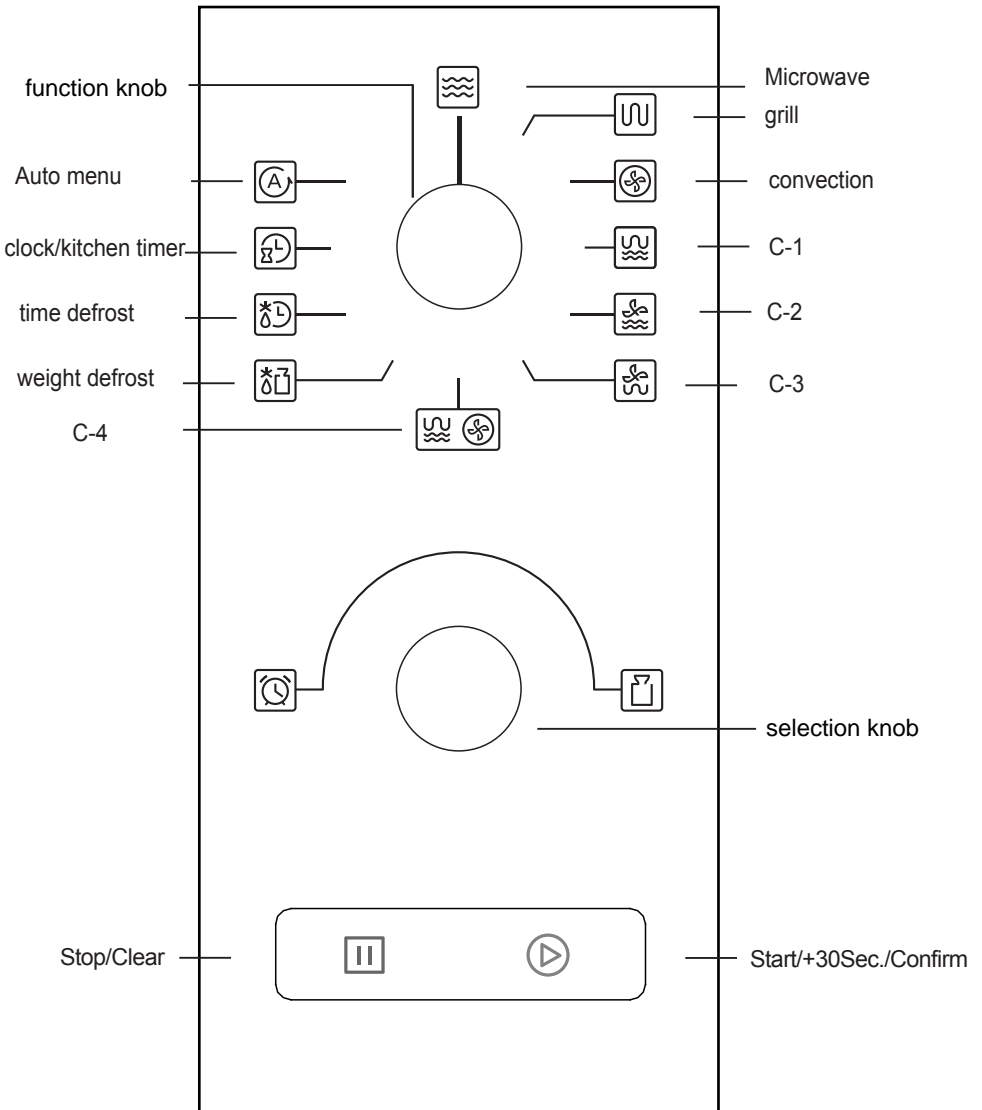



Control pannel



Operation Instructions





When the microwave oven is electrified, the screen will display "0:00",

1. Clock Setting

- 1) Turn the function knob to "  ", the screen will display "00:00".
- 2) Press "  ", the hour figures will flash.
- 3) Turn "  " to adjust the hour figures, the input time should be within 0--23.
- 4) Press "  ", the minute figures will flash.
- 5) Turn "  " to adjust the minute figures, the input time should be within 0--59.
- 6) Press "  " to finish clock setting. ":" will flash.

Note: In the process of clock setting, if you press "  ", the oven will go back to the previous status automatically. The setting will be cancelled.





2. Kitchen Timer

- 1) Turn the function knob to "  ", the screen will display "00:00", this is clock setting.
Then turn "  " and "00:00" will flash, this is kitchen timer setting.
- 1) Press "  " confirm, the screen will display 00:00.
- 2) Turn "  " to adjust the timer time. Time setting should be 0:05-95:00.
- 3) Press "  " to confirm setting.
- 4) When the timer time arrives, the buzzer will ring 5 times. If the clock has been set, screen will display the current time.

Note: 1) The kitchen timer is different from 24-hour system, it is a timer.

2) During kitchen timer, any program cannot be set.

3. Microwave Cooking







- 1) Turn the function knob to "  " , "P100" will flash.
- 2) Turn "  " to choose different microwave power, and "P100, P80, P50, P30, P10" will display in order.
- 3) Press "  " to confirm the power level.
- 4) Turn "  " to adjust the cooking time. The time setting should be 0:05-95:00.
- 5) Press "  " to start cooking.

Power	100%	80%	50%	30%	10%
Display	P100	P80	P50	P30	P10





NOTE: the step quantities for the adjustment time of the coding switch are as follow:

0---1 min	: 5 seconds
1---5 min	: 10 seconds
5---10 min	: 30 seconds
10---30 min	: 1 minute
30---95 min	: 5 minutes



4. Convection Cooking(with preheating function)

- 1) Turn the function knob to "  ", "130°C" will display and flash.
turn "  " to choose the convection temperature (130-220°C).
- 2) Press "  " to confirm the temperature.
- 3) Press "  " again to start preheating.
- 4) The temperature figure will flash when temperature arrives and buzzer will ring twice reminding you to put food in, then close the door.
- 5) Turn "  " to adjust the cooking time, the maximum time that can be set is 95 minutes.
- 6) Press "  " to start cooking.

5. Convection Cooking(without preheating function)

- 1) Turn the function knob to "  ", "130°C" will display and flash.
turn "  " to choose the convection temperature (130-220°C).
- 2) Press "  " to confirm the temperature.
- 3) Turn "  " to adjust the cooking time, the maximum time that can be set is 95 minutes.
- 4) Press "  " to start cooking.



6. Grill Cooking

- 1) Turn the function knob to "  " and the screen displays "G".
- 2) Turn "  " to adjust the cooking time, the maximum time that can be set is 95 minutes.
- 3) Press "  " to start cooking.



Note: If half the grill time passes, the oven sounds twice, and this is normal. In order to have a better effect of grilling food, you should turn the food over, close the door, and then press "  " to continue cooking.
If no operation, the oven will continue working.

7. Combination Cooking



7.1. Combination Cooking(C-1)

- 1) Turn the function knob to "  " and the screen displays "C-1".
- 2) Turn "  " to adjust the cooking time, the maximum time that can be set is 95 minutes.
- 3) Press "  " to start cooking.



7.2. Combination Cooking(C-2)

- 1) Turn the function knob to "  " and the screen displays "C-2".
- 2) Turn "  " to adjust the cooking time, the maximum time that can be set is 95 minutes.
- 3) Press "  " to start cooking.

7.3. Combination Cooking(C-3)



- 1) Turn the function knob to "  " and the screen displays "C-3".
- 2) Turn "  " to adjust the cooking time, the maximum time that can be set is 95 minutes.
- 3) Press "  " to start cooking.

7.4. Combination Cooking(C-4)



- 1) Turn the function knob to "  " and the screen displays "C-4".
- 2) Turn "  " to adjust the cooking time, the maximum time that can be set is 95 minutes.
- 3) Press "  " to start cooking.

Function	Display	Microwave	Grill	Convection
Combi.1	C-1	●	●	
Combi.2	C-2	●		●
Combi.3	C-3		●	●
Combi.4	C-4	●	●	●



8. Speedy Cooking

- 1) In waiting state, press "  " key to cook with 100% power level for 30 seconds. Each press on the same key can increase 30 seconds. The maximum cooking time is 95 minutes.
- 2) During the microwave, grill, combination, convection cooking and defrost by time, press "  " to increase the cooking time by 30 seconds.





9. Defrost By Weight

- 1) Turn the function knob to "  ", "dEF1" will be displayed.
- 2) Turn "  " to adjust defrost weight. "g" indicator will light, The weight input should be 100-2000g.
- 3) Press "  " to start defrosting.

10. Defrost By Time

- 1) Turn the function knob to "  ", "dEF2" will be displayed.
- 2) Turn "  " to select the cooking time. The maximum cooking time is 95 minutes.
- 3) Press "  " to start defrosting.

11. Auto Menu Cooking

- 1) Turn the function knob to "  " the screen displays "A1", then turn "  " to choose the menu from "A1" to "A10".
- 2) Press "  " to confirm the menu you need.
- 3) Turn "  " to choose the food weight or portion.
- 4) Press "  " to start cooking.

Note: 1) Cake menu is under convection cooking with 160 °C -warm-up function, and you should preheat first following the auto menu operation, when the oven reaches the temperature, it will stop working and sound to remind opening the door to put cake in, then press "  " to start cooking.

2) When roast chicken is selected and 2/3 of the time has passed, it will ring twice to tell you to turn over the food. You can just leave it continue. For better result, turn the food over, close the door, and then press "  " to continue cooking.

12. Child Lock Function

Lock: In waiting state, press "  " key for 3 seconds. There will be a long "beep" denoting entering the child lock function. The screen will display current time if the clock has been set. Otherwise, "0:00" will display.

Unlock: In locked state, press "  " key for 3 seconds. There will be a long "beep" denoting that the lock is released.

13. Cooking end reminding function

When the cooking is over, the buzzer will sound 5 "beep" to alert user the cooking is finished.

Auto menu Chart

Menu	Weight	Display	Power
A1 Auto Reheat	150g	150	100%
	250g	250	
	350g	350	
	450g	450	
	600g	600	
A2 Potato	1 (about 230g)	1	100%
	2 (about 460g)	2	
	3 (about 690g)	3	
A3 Meat	150g	150	100%
	300g	300	
	450g	450	
	600g	600	
A4 Vegetable	150g	150	100%
	350g	350	
	500g	500	
A5 Fish	150g	150	80%
	250g	250	
	350g	350	
	450g	450	
	650g	650	
A6 Pasta	50g(with water 450g)	50	80%
	100g(with water 800g)	100	
	150g(with water 1200g)	150	
A7 Soup	200ml	200	100%
	400ml	400	
	600ml	600	
A8 Cake	475g	475	Preheat at 160 degrees
A9 Pizza	200g	200	C-4
	300g	300	
	400g	400	
A10 Chicken	500g	500	C-4
	750g	750	
	1000g	1000	
	1200g	1200	

Trouble shooting

Normal	
Microwave oven interfering TV reception	Radio and TV reception may be interfered when microwave oven operating. It is similar to the interference of small electrical appliances, like mixer, vacuum cleaner, and electric fan. It is normal.
Dim oven light	In low power microwave cooking, oven light may become dim. It is normal.
Steam accumulating on door, hot air out of vents	In cooking, steam may come out of food. Most will get out from vents. But some may accumulate on cool place like oven door. It is normal.
Oven started accidentally with no food in.	It is forbidden to run the unit without any food inside. It is very dangerous.

Trouble	Possible Cause	Remedy
Oven can not be started.	(1) Power cord not plugged in tightly.	Unplug. Then plug again after 10 seconds.
	(2) Fuse blowing or circuit breaker works.	Replace fuse or reset circuit breaker (repaired by professional personnel of our company)
	(3) Trouble with outlet.	Test outlet with other electrical appliances.
Oven does not heat.	(4) Door not closed well.	Close door well.



According to Waste of Electrical and Electronic Equipment (WEEE) directive, WEEE should be separately collected and treated. If at any time in future you need to dispose of this product please do NOT dispose of this product with household waste. Please send this product to WEEE collecting points where available.

Service



www.blaupunkt-einbaugeraete.com

 **1800 252 878 658**

Australia

CustomerCare@blaupunktAU.com